

KENWOOD

INSTRUCTION MANUAL

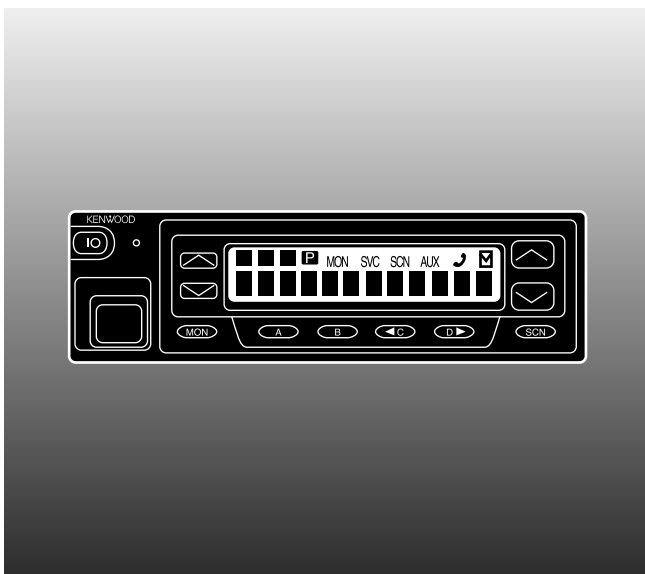

VHF FM TRANSCEIVER

TK-780 series

UHF FM TRANSCEIVER

TK-880 series

800 MHz FM TRANSCEIVER

TK-980

900 MHz FM TRANSCEIVER

TK-981

KENWOOD CORPORATION

© B62-1549-00 (K)
09 08 07 06 05 04 03 02 01 00

THANK YOU!

We are grateful you chose **KENWOOD** for your personal mobile applications. We believe this easy-to-use transceiver will provide dependable communications to keep personnel operating at peak efficiency.

KENWOOD transceivers incorporate the latest in advanced technology. As a result, we feel strongly that you will be pleased with the quality and features of this product.

MODELS COVERED BY THIS MANUAL

The models listed below are covered by this manual:

- **TK-780:** VHF FM Transceiver
- **TK-780H:** VHF FM Transceiver
- **TK-880:** UHF FM Transceiver
- **TK-880H:** UHF FM Transceiver
- **TK-980:** 800 MHz FM Transceiver
- **TK-981:** 900 MHz FM Transceiver

PRECAUTIONS

Please observe the following precautions to prevent fire, personal injury, and transceiver damage.

- Do not attempt to configure the transceiver while driving; it is too dangerous.
- Do not modify the transceiver for any reason.
- Do not expose the transceiver to long periods of direct sunlight, nor place it near heating appliances.
- Do not place the transceiver in excessively dusty, humid, or wet areas, nor on unstable surfaces.
- If an abnormal odor or smoke is detected coming from the transceiver, turn OFF the power immediately. Contact your **KENWOOD** dealer.

CONTENTS

UNPACKING AND CHECKING EQUIPMENT	1
SUPPLIED ACCESSORIES	1
PREPARATION	2
TOOLS REQUIRED	2
POWER CABLE CONNECTION	2
INSTALLING THE TRANSCEIVER	3
ORIENTATION	4
FRONT PANEL AND MICROPHONE	4
DISPLAY	5
REAR PANEL	5
PROGRAMMABLE AUXILIARY FUNCTIONS	6
BASIC OPERATIONS	8
OPERATION OVERVIEW	8
Trunking Format	8
Conventional Format (TK-780 series and TK-880 series only)	8
SWITCHING POWER ON/OFF	8
ADJUSTING THE VOLUME	8
SELECTING A SYSTEM/ GROUP/ CHANNEL	8
TIME-OUT TIMER (TOT)	8
HORN ALERT	8
TRUNKING FORMAT	9
TRUNKED OPERATION	9
Placing a Dispatch Call	9
Receiving a Dispatch Call	9
Placing a Telephone Call	9
Receiving a Telephone Call	10
CONVENTIONAL OPERATION	10
Transmitting	10
Receiving	10
SYSTEM SCAN	10
Scanning Trunked Systems	11
Scanning Conventional Systems	11
Scan Lockout	11
Scan Revert	11
GROUP SCAN	11

CONVENTIONAL FORMAT	
(TK-780 series and TK-880 series only)	12
CONVENTIONAL OPERATION	12
Transmitting	12
Receiving	12
SCAN	13
Priority Scan	13
2-TONE SIGNALLING	13
FleetSync™: ALPHANUMERIC TWO-WAY PAGING FUNCTION ...	14
KEY FUNCTIONS	14
OPTIONAL FEATURES	14
SELCALL (SELECTIVE CALLING)	15
Transmitting	15
Receiving	15
Identification Codes	15
Reviewing Caller IDs in the Stack Memory	15
STATUS MESSAGE	16
Transmitting	16
Receiving	16
Reviewing Messages in the Stack Memory	17
Automatic Status Response	17
DTMF (DUAL TONE MULTI FREQUENCY) CALLS	18
MAKING A DTMF CALL	18
DTMF SIGNALLING	19
DBD (DEAD BEAT DISABLE)	19
AUDIBLE USER FEEDBACK TONES	20
NOTICES TO THE USER	21

UNPACKING AND CHECKING EQUIPMENT

Note: The following unpacking instructions are for use by your **KENWOOD** dealer, an authorized **KENWOOD** service facility, or the factory.

Carefully unpack the transceiver. We recommend that you identify the items listed in the following table before discarding the packing material. If any items are missing or have been damaged during shipment, file a claim with the carrier immediately.

SUPPLIED ACCESSORIES

Item	Part Number	Quantity
Microphone and microphone cable	T91-0621-XX	1
Microphone hanger with self-tapping screws	J19-1584-XX	1 set
DC power cable	E30-3339-XX	1
Mounting bracket	J29-0627-XX	1
Speaker jack cap	B09-0235-XX	1
Screw set: <ul style="list-style-type: none"> • Self-tapping screw (4 pieces) • Hex-headed screw with washer (4 pieces) • Spring washer (4 pieces) • Flat washer (4 pieces) 	N99-0395-XX	1
Warranty card (U.S.A./ Canada only)	—	1
Instruction manual	B62-1549-XX	1

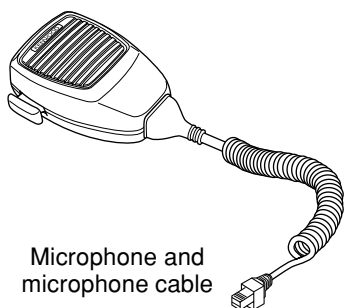

Microphone and microphone cable

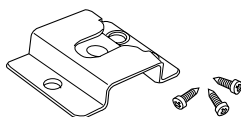

Microphone hanger with self-tapping screws

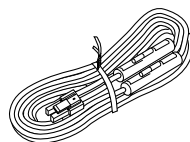

DC power cable

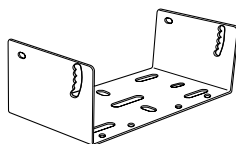

Mounting bracket



Speaker jack cap



Screw set

PREPARATION



WARNING

Various electronic equipment in your vehicle may malfunction if they are not properly protected from the radio frequency energy which is present while transmitting. Electronic fuel injection, anti-skid braking, and cruise control systems are typical examples of equipment that may malfunction. If your vehicle contains such equipment, consult the dealer for the make of vehicle and enlist his/her aid in determining if the equipment will perform normally while transmitting.

Note: The following preparation instructions are for use by your **KENWOOD** dealer, an authorized **KENWOOD** service facility, or the factory.

TOOLS REQUIRED

Note: Before installing the transceiver, always check how far the mounting screws will extend below the mounting surface. When drilling mounting holes, be careful not to damage vehicle wiring or parts.

The following tools are required for installing the transceiver:

- 6 mm (1/4 inch) or larger electric drill
- Drill bits (sizes listed below) and circle cutters

Drill Bit Size	Purpose
4.2 mm (5/32 inch)	5 x 16 mm self-tapping screws
3.2 mm (1/8 inch)	4 x 16 mm self-tapping screws

POWER CABLE CONNECTION



CAUTION

The transceiver operates in 12 V negative ground systems only! Check the battery polarity and voltage of the vehicle before installing the transceiver.

- 1 Check for an existing hole, conveniently located in the firewall, where the power cable can be passed through.
 - If no hole exists, use a circle cutter to drill the firewall, then install a rubber grommet.
- 2 Run the two power cable leads through the firewall and into the engine compartment, from the passenger compartment.
- 3 Connect the red lead to the positive (+) battery terminal and the black lead to the negative (-) battery terminal.
 - Locate the fuse as close to the battery as possible.
- 4 Coil and secure the surplus cable with the provided retaining band.
 - Be sure to leave enough slack in the cables so the transceiver can be removed for servicing while keeping the power applied.

INSTALLING THE TRANSCEIVER



For passenger safety, install the transceiver securely, using the supplied mounting bracket, so the transceiver will not break loose in the event of a collision.

- 1 Mark the position of the holes in the dash by using the mounting bracket as a template. Drill the holes, then attach the mounting bracket using the supplied 5 x 16 mm screws.
 - Be sure to mount the transceiver in a location where the controls are within easy reach of the user, and where there is sufficient space at the rear of the transceiver for cable connections.
- 2 Connect the antenna and the supplied power cable to the transceiver.
- 3 Slide the transceiver into the mounting bracket and secure it using the supplied hex-headed screws.
- 4 Mount the microphone hanger, using the supplied 4 x 16 mm screws, in a location where it will be within easy reach of the user.
 - The microphone and microphone cable should be mounted in a place where they will not interfere with the safe operation of the vehicle.
- 5 Connect one plug of the microphone cable to the jack on the base of the microphone, and the other plug to the microphone jack on the front panel of the transceiver. Place the microphone on the hanger.

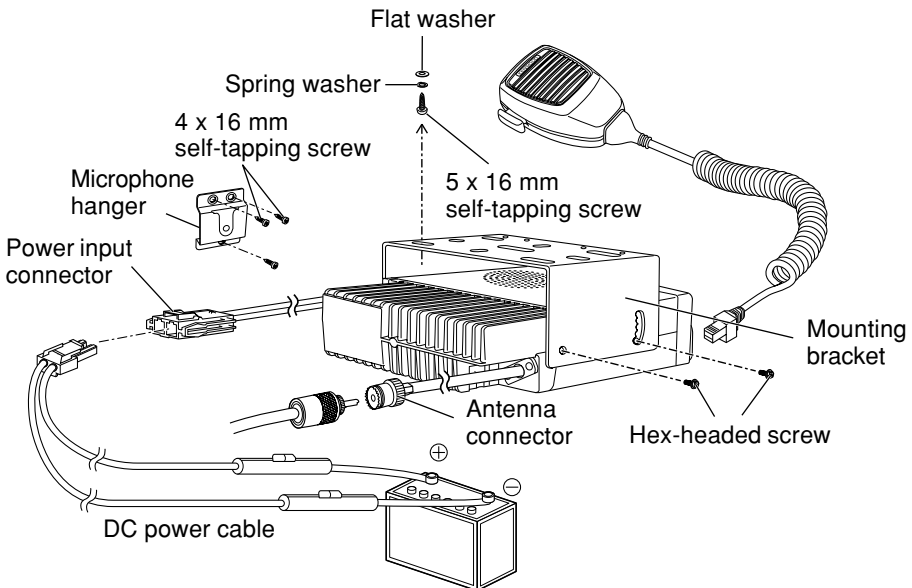

* The above diagram shows the TK-780 series/ TK-880 series transceiver. The antenna connector of the TK-980 and TK-981 transceivers is different.

ORIENTATION

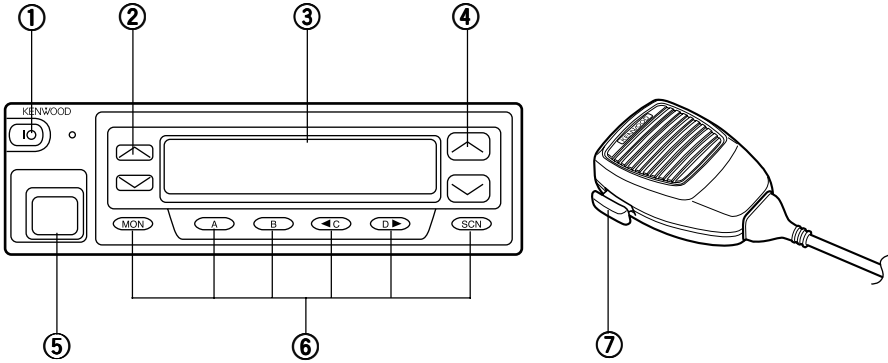

FRONT PANEL AND MICROPHONE

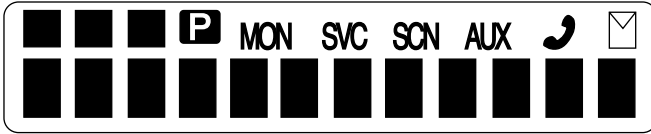

- ① **IO** (Power) switch
Press to switch the transceiver ON (or OFF).
- ② **^ / v** keys
Press these keys to activate their programmable auxiliary functions {page 6}.
- ③ **Display**
See page 5 for more information.
- ④ **^ / v** keys
Press these keys to activate their programmable auxiliary functions {page 6}.
- ⑤ **Microphone connector**
Insert the microphone plug into this connector.
- ⑥ **MON, A, B, ◀C, D▶, and SCN** keys
Press these keys to activate their programmable auxiliary functions {page 6}.
- ⑦ **PTT** switch
To transmit, press and hold this switch, then speak into the microphone. Release to receive.

DISPLAY



Indicator	Description
■ ■ ■	Displays the system, group, and channel numbers. Also displays various functions which have been programmed by your dealer.
P	Appears when the selected channel is programmed as priority.
MON	Appears when the key programmed as Monitor is pressed.
SVC	This icon is not used on this transceiver.
SCN	Appears when you are using Scan mode.
AUX	Appears when the auxiliary function is activated.
	In Trunking Format, appears when the selected group is programmed as telephone IDs. In Conventional Format, appears when you are using the Operator Selectable Tone function.
	Flashes when you receive a message. Lights when a message is stored in the stack memory.
■■■■■■■■■■	Displays the system, group, and channel numbers. Your dealer can program the system, group, and channel names with up to 10 characters, in place of numbers. The left most display is used as a delete indicator (▶) in Trunking Format and an add indicator (▼) in Conventional Format. The right most display is used for the Selective Call (*:) or Scrambler (_) function. The delete/ add indicators show the systems/ channels that are locked/ not locked out of the scanning sequence. Selective Call and Scrambler are optional functions that can be programmed by your dealer. Also displays received messages when using FleetSync™.

REAR PANEL

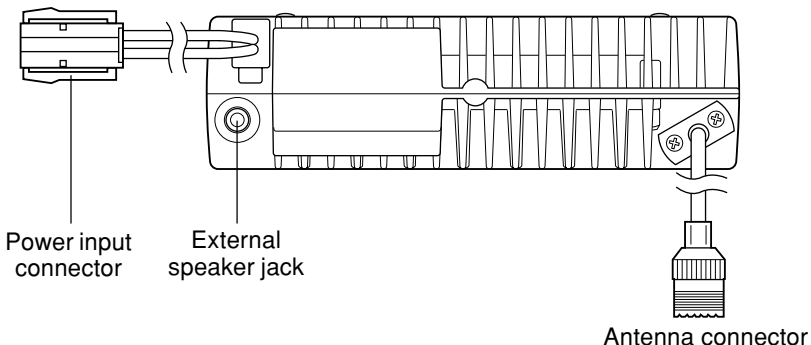

* The above diagram shows the TK-780 series/ TK-880 series transceiver. The antenna connector of the TK-980 and TK-981 transceivers is different.

PROGRAMMABLE AUXILIARY FUNCTIONS

Keys ②, ④, and ⑥ {page 4} can be programmed with the auxiliary functions listed in the following table. The keys can only be programmed with functions, depending on whether you are using Conventional Format or Trunking Format. Please contact your dealer for further details on these functions.

Note:

- ◆ If “Function” is programmed onto one of the above mentioned keys, the DTMF keypad (keypad models only) can also be used for additional programmable keys.
- ◆ Only the TK-780 series and TK-880 series transceivers support Conventional Format.

Function	Conventional Format	Trunking Format
Auto Tel	No	Yes
AUX A	Yes	Yes
AUX B ¹	Yes	Yes
Channel Down	Yes	No
Channel Up	Yes	No
DTMF ID (BOT)	Yes	Yes
DTMF ID (EOT)	Yes	Yes
Display Character	Yes	Yes
Emergency ²	Yes	Yes
Function	Yes	Yes
Group Down	Yes	Yes
Group Up	Yes	Yes
Home Channel	Yes	No
Home Group	No	Yes
Horn Alert	Yes	Yes
Key Lock	Yes	Yes
Memory (RCL/STO)	Yes	Yes
Memory (RCL)	Yes	Yes
Memory (STO)	Yes	Yes
Message Mode	Yes	Yes
Monitor A (Monitor Unmute (Momentary))	Yes	Yes
Monitor B (Monitor Unmute (Toggle))	Yes	Yes
Monitor C (Carrier Squelch (Momentary))	Yes	Yes
Monitor D (Carrier Squelch (Toggle))	Yes	Yes

Function	Conventional Format	Trunking Format
Operator Sel Tone	Yes	No
Public Address	Yes	Yes
Redial	Yes	Yes
Scan	Yes	Yes
Scan Del/Add	Yes	Yes
Scan Temporary Delete	No	Yes
Send GPS ³	Yes	Yes
System Down	No	Yes
System Up	No	Yes
Scrambler ⁴	Yes	Yes
Talk Around	Yes	No
Tel Disconnect	No	Yes
Volume Down	Yes	Yes
Volume Up	Yes	Yes

¹ This function can be selected only when the Scrambler/ ANI board has not been installed.

² This function can be used only with a foot switch.

³ This function can be selected only when the FleetSync™ enhanced option and a GPS receiver have been installed.

⁴ This function can be selected only when the Scrambler board has been installed.

BASIC OPERATIONS

OPERATION OVERVIEW

Your dealer can program your transceiver for Trunking or Conventional Format.

■ Trunking Format

This format can handle up to 600 channels in conventional mode, and 32 systems with up to 250 groups in each system in trunking mode. Systems, groups, channels, and their functions are programmed by your dealer.

■ Conventional Format (TK-780 series and TK-880 series only)

This format can handle up to 250 groups with 250 channels in each group. The transceiver can be used only in conventional mode. Groups, channels, and their functions are programmed by your dealer.

SWITCHING POWER ON/OFF

Press the **IO** switch to switch the transceiver ON (or OFF).

ADJUSTING THE VOLUME

Press the key programmed as **Volume Up** or **Volume Down** to adjust the volume. **Volume Up** increases the volume and **Volume Down** decreases it.

SELECTING A SYSTEM/ GROUP/ CHANNEL

Select the desired system and group (Trunking Format) using the keys programmed with the **System** and **Group** functions.

Select the desired group and channel (Conventional Format) using the keys programmed with the **Group** and **Channel** functions.

TIME-OUT TIMER (TOT)

The purpose of the Time-out Timer is to prevent any caller from using a channel for an extended period of time.

If you continuously transmit for a period of time that exceeds the programmed time, the transceiver will stop transmitting and an alert tone will sound. To stop the tone, release the **PTT** switch.

Your dealer can program the TOT time in the range of 15 seconds to 10 minutes.

HORN ALERT

If Horn Alert has been installed by your dealer, your vehicle horn, or some other type of external alert, will sound when certain calls are received. This is a useful function when you are away from your vehicle.

TRUNKING FORMAT

TRUNKED OPERATION

■ Placing a Dispatch Call

- 1 Select the desired system and group using the **System** and **Group** keys.
- 2 Press the **PTT** switch.
- 3 If a tone does not sound, communication is possible; start speaking into the microphone. Release the **PTT** switch to receive.
 - For best sound quality at the receiving station, hold the microphone approximately 1.5 inches (3 ~ 4 cm) from your mouth.
- 4 When your conversation is finished, return the microphone to its hanger.

■ Receiving a Dispatch Call

- 1 Select the desired system and group using the **System** and **Group** keys. (If the Scan function has been programmed, you can switch it ON or OFF as desired.)
- 2 When you hear the dispatcher's voice, readjust the volume as necessary.

■ Placing a Telephone Call

Note: You can only make a telephone call if the telephone service is available and you have an optional keypad microphone. Refer to "MAKING A DTMF CALL" on page 18. Consult your dealer for further details.

- 1 Select the desired system and group using the **System** and **Group** keys.
- 2 Press and hold the **PTT** switch for approximately 1 second to ensure a connection.
 - Confirm that there is a dial tone after releasing the **PTT** switch.
- 3 Dial using the microphone keypad.
 - After dialing, wait for a response from the called party.
- 4 When the called party responds, press the **PTT** switch and speak into the microphone. Release the **PTT** switch to receive.
 - Only one person can speak at a time.
- 5 To end the call, press the **#** key or the key programmed as **Tel Disconnect**.

■ Receiving a Telephone Call

- 1 Select the desired system and group using the **System** and **Group** keys. (If the Scan function has been programmed, you can switch it ON or OFF as desired.)
 - A ringing tone will sound when a call is received.
- 2 Press and hold the **PTT** switch to speak, and release it to listen.
 - Only one person can speak at a time.
- 3 To end the call, press the **#** key or the key programmed as **Tel Disconnect**.

CONVENTIONAL OPERATION

■ Transmitting

Note: Before transmitting, monitor the channel to make sure it is not already in use. If the selected group is programmed with QT (Quiet Talk) or DQT (Digital Quiet Talk), remove the microphone from the hook to disable QT or DQT, then listen to the channel to make sure nobody is talking on it. If the selected group is not programmed with QT or DQT, simply listen to the channel to make sure nobody is talking on it. In this case, you need not remove the microphone from the hook.

- 1 Select the desired system and group using the **System** and **Group** keys.
 - If the channel is busy, wait until it becomes free.
- 2 Press the **PTT** switch and speak into the microphone. Release the **PTT** switch to receive.
 - For best sound quality at the receiving station, hold the microphone approximately 1.5 inches (3 ~ 4 cm) from your mouth.
- 3 When your conversation is finished, return the microphone to its hanger.

■ Receiving

- 1 Select the desired system and group using the **System** and **Group** keys. (If the Scan function has been programmed, you can switch it ON or OFF as desired.)
- 2 When you hear the dispatcher's voice, readjust the volume as necessary.

SYSTEM SCAN

If the Scan function is programmed, systems can be scanned by pressing the key programmed as **Scan**. When the **Scan** key is pressed, the SCN indicator and “-SCAN-” or the revert system/ group number, appear on the display and scanning starts. The systems not locked out of the scanning sequence are scanned.

When a call is received, scanning stops and the system and group digits appear. Press the **PTT** switch and speak into the microphone to respond to the call. The transceiver will continue scanning after an adjustable time delay if the **PTT** switch is released and no further signal is received.

■ Scanning Trunked Systems

When scanning trunked systems, the revert groups and the groups not locked out of the scanning sequence are scanned. See “GROUP SCAN”, below.

■ Scanning Conventional Systems

When scanning conventional systems, the revert groups and the groups not locked out of the scanning sequence are scanned. See “GROUP SCAN”, below.

■ Scan Lockout

If a programmable auxiliary key is programmed with **Scan DEL/ADD**, each system can be locked out of the scan sequence manually. The delete indicator (▶) will appear in the display when the selected system is locked out.

■ Scan Revert

You can select revert systems and groups using the **System** and **Group** keys.

Four types of Scan Reverts which can be programmed by your dealer are available:

- **Last Called Revert:** The last system/ group received is assigned as the new revert system and group.
- **Last Used Revert:** The last system/ group responded to is assigned as the new revert system and group.
- **Selected:** The last system/ group selected is assigned as the new revert system and group.
- **Selected + Talkback:** If the system/ group has been changed during Scan, the newly selected system/ group is assigned as the new revert system and group. The transceiver “talks back” on the current receive group.

GROUP SCAN

Group Scan is available for both trunked and conventional systems. This feature is useful when more than one group is programmed in a system. Group Scan is set by your dealer on request. It scans the revert groups as well as groups that are allowed to be scanned.

When a call is received, the group indicator shows the group number, and that group becomes the revert group. Simply press the **PTT** switch to respond to the call.

You can also perform Group Scan while using a priority channel. Please contact your dealer for information concerning Priority Scan.

CONVENTIONAL OPERATION

■ Transmitting

Note: Before transmitting, monitor the channel to make sure it is not already in use. If the selected channel is programmed with QT (Quiet Talk) or DQT (Digital Quiet Talk), remove the microphone from the hook to disable QT or DQT, then listen to the channel to make sure nobody is talking on it. If the selected channel is not programmed with QT or DQT, simply listen to the channel to make sure nobody is talking on it; in this case, you need not remove the microphone from the hook.

- 1 Select the desired group and channel using the **Group** and **Channel** keys.
 - If the channel is busy, wait until it becomes free.
- 2 Press the **PTT** switch and speak into the microphone. Release the **PTT** switch to receive.
 - For best sound quality at the receiving station, hold the microphone approximately 1.5 inches (3 ~ 4 cm) from your mouth.
- 3 When your conversation is finished, return the microphone to its hanger.

■ Receiving

- 1 Select the desired group and channel using the **Group** and **Channel** keys. (If the Scan function has been programmed, you can switch it ON or OFF as desired.)
- 2 When you hear the dispatcher's voice, readjust the volume as necessary.

SCAN

If the Scan function is programmed, groups or channels can be scanned by pressing the key programmed as **Scan**. Scan can be used as either Single Scan or Multi Scan. Single Scan monitors only the channels of a single group. Multi Scan monitors all channels of every group. When the **Scan** key is pressed, the SCN indicator and “-SCAN-” or the revert group/ channel number, appear on the display and scanning starts.

When a call is received, scanning stops and the group and channel digits appear. Press the **PTT** switch and speak into the microphone to respond to the call. The transceiver will continue scanning after an adjustable time delay, if the **PTT** switch is released, and no further signal is received.

When the displayed group is not locked out of the scanning sequence, the add indicator (▼) will appear on the display.

■ Priority Scan

The priority channel must be programmed in order for Priority Scan to function.

The transceiver will automatically change to the priority channel when a signal is received on it, even if a signal is being received on a normal channel.

The **P** indicator appears when the displayed channel is the priority channel.

2-TONE SIGNALLING

2-Tone Signalling is either activated or deactivated by your dealer.

2-Tone Signalling only opens the squelch when the transceiver receives two tones corresponding to those set up in the transceiver. When the squelch opens, you will be able to hear the caller without any further action.

After a correct 2-Tone signal is received and the squelch opens, pressing the key programmed as **Monitor** will cancel the connection.

If your dealer programmed Transpond for 2-Tone Signalling, your transceiver will automatically send an acknowledgment signal to the station that called you with a correct 2-Tone signal. Transpond does not function when you are called as a Group call.

If your dealer programmed Tone Alert for 2-Tone Signalling, your transceiver will emit a beep when the correct 2-Tone signal is received.

Note: This transceiver is only capable of decoding 2-Tone Signals. It cannot encode a 2-Tone Signal.

FleetSync™: ALPHANUMERIC TWO-WAY PAGING FUNCTION

FleetSync™ is an Alphanumeric Two-way Paging Function, and is a protocol owned by **KENWOOD** Corporation. FleetSync™ enables a variety of paging functions on your transceiver, some of which depend on dealer programming.

KEY FUNCTIONS

Key	Function
A, #	Press to change the transceiver mode as shown in the diagram below. (The # key is available on keypad models only.)
SCN	Press while in Stack Mode to toggle between the received message and the caller's ID. Press and hold for more than 1 second to delete the displayed message.
◀C, D▶	Press while in Selcall or Status Mode to select a station ID or your transceiver status.
PTT	Press to initiate a call.
(DTMF Keypad)	Use the DTMF keypad to enter Selcall or Status numbers (keypad models only).

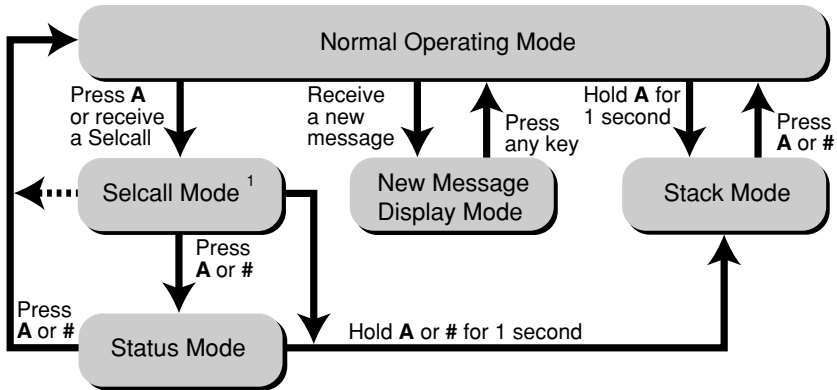

¹ Depending on how your dealer programmed the transceiver, Selcall Mode may be skipped or the transceiver may exit Selcall Mode automatically (as shown by the dash arrow).

OPTIONAL FEATURES

Short Messages: Received short messages (maximum of 48 characters) are displayed the same as Status messages {page 16}, however only 4 short messages can be stored in the stack memory. “M” (Message) and the message number appear with the message.

GPS Report: If a GPS unit (NMEA-0183 format) is installed on the transceiver and the Send GPS function is programmed onto a key by your dealer, you can press the programmed key to send your location data.

SELCALL (SELECTIVE CALLING)

A Selcall is a voice call to a particular station or to a group of stations.

■ Transmitting

- 1 Select your desired system and group (or group and channel).
- 2 Press the **A** key to enter Selcall Mode.
- 3 Press the ◀C or D▶ key to select the ID of the station you want to call.
 - You can also enter digits by using the DTMF keypad if Manual Dial is enabled. (Press ✖ to erase an incorrect digit.)
- 4 Press the **PTT** switch and begin your conversation.

■ Receiving

An alert tone will sound, the transceiver will automatically enter Selcall Mode, and the calling station's ID will appear when a Selcall is received.

To respond to the call, press the **PTT** switch and speak into the microphone.

■ Reviewing Caller IDs in the Stack Memory

The mail icon (✉) will flash when a Selcall call is received and stacked.

- 1 Press and hold the **A** key for more than 1 second to enter Stack Mode.
 - The last received Caller ID is displayed with the Caller ID number. "I" (ID) appears with the number.
- 2 Press the ◀C or D▶ key to select the ID you want to view (if more than one ID is stored in the stack memory).
- 3 To erase the ID, press and hold the **SCN** key for more than 1 second.

■ Identification Codes

An ID code is a combination of a 3-digit Fleet number and a 4-digit ID number. Each transceiver must have its own Fleet and ID number.

- Enter a Fleet number (100 ~ 349) to make a group call.
- Enter an ID number (1000 ~ 4999) to make an individual call in your fleet.
- Enter a Fleet number followed by an ID number to make an individual call in your desired fleet (Inter-fleet call).
- Select "ALL" Fleet and "ALL" ID to make a call to all units (Broadcast call).
- Select "ALL" Fleet and enter an ID number to make a call to the selected ID in all fleets (Supervisor call).

Note:

- ◆ Broadcast and Supervisor calls are programmed functions that cannot be made with a keypad.
 - ◆ The ID range may be limited by programming.
-

STATUS MESSAGE

You can send and receive 2-digit Status messages (10 ~ 79) which may be decided in your talk group. Messages can contain up to 16 alphanumeric characters.

A maximum of 9 received messages can be stored in the stack memory of your transceiver. These saved messages can be reviewed after reception. If the stack memory is full, the oldest message will be erased when a new message is received. The mail icon () lights when a message is stored in the stack memory.

Note: All stored messages will be cleared when the transceiver power is turned OFF.

■ Transmitting

- 1 Select your desired system and group (or group and channel).
- 2 Press the **A** key to enter Selcall Mode.
- 3 Press the **◀C or D▶** key to select the ID of the station you want to call.
 - You can also enter digits by using the DTMF keypad if Manual Dial is enabled. (Press * to erase an incorrect digit.)
- 4 Press the **A** or **#** key to enter Status Mode.
- 5 Press the **◀C or D▶** key to select the status you want to transmit.
 - You can also enter digits by using the DTMF keypad if Manual Dial is enabled. (Press * to erase an incorrect digit.)
- 6 Press the **PTT** switch to initiate the Status call.
 - “COMPLETE” is displayed when the call has been successfully transmitted.

■ Receiving

The mail icon () will flash and a calling ID or text message will appear when a Status call is received.

- The display alternates between the caller ID and the message.

Press any key to return to Normal Operation Mode.

■ Reviewing Messages in the Stack Memory

- 1 Press and hold the **A** key for more than 1 second to enter Stack Mode.
 - The last received message is displayed with the message number. “S” (Status) appears with the number.
- 2 Press the ◀**C** or **D**▶ key to select the message you want to view (if more than one message is stored in the stack memory).
- 3 Press the **SCN** key to toggle between the message and the caller's ID.
- 4 To erase the message, press and hold the **SCN** key for more than 1 second.

■ Automatic Status Response

If you pre-select a status number and then leave the transceiver in Status Mode, the transceiver will automatically respond with that status number when a request from the base station is received. (The base station request function is optional.)

DTMF (DUAL TONE MULTI FREQUENCY) CALLS

MAKING A DTMF CALL

Note: To make a DTMF call, you must have an optional microphone with a DTMF keypad. Ask your dealer for more information.

There are two methods of making a DTMF call:

- Manual dialing
- Store and sending

To make a call by dialing manually:

- 1 Press and hold the **PTT** switch.
- 2 Enter the desired digits using the microphone keypad.
 - The corresponding DTMF tones sound each time you press a key.
 - If you release the **PTT** switch, transmit mode will end even if the complete number has not been sent.
 - If your dealer has activated the Keypad Auto PTT function, you need not hold down the **PTT** switch while pressing the keys on the keypad. The DTMF code will be sent automatically when you press a key.

To make a call by storing and sending:

- 1 Enter the desired digits using the microphone keypad.
 - The digits appear on the display as you enter them.
- 2 After entering the complete number, press the **PTT** switch.
 - If you are using the transceiver in a Conventional mode and Format, the DTMF code is transmitted after pressing the **PTT** switch.
 - If you are using the transceiver in a Trunking system, the DTMF code is transmitted after a connection is established. Releasing the **PTT** switch before a connection is established will stop the transmission from occurring.
 - If you are using the transceiver in a RIC (Repeater Inter-Connect) Trunking system, the DTMF code is transmitted after a connection with the telephone system is established. If you press the key programmed as **Auto Tel** instead of the **PTT** switch, the call will automatically connect to the repeater, and the DTMF code will be transmitted.

Note:

- ◆ Store and send must first be activated by your dealer in order for it to function.
 - ◆ You can only store up to 16 digits before sending. Entering more than 16 digits will cause an error tone to sound.
 - ◆ In store and sending mode, if you switch the power OFF before sending the number, the number will be cleared from memory.
-

DTMF SIGNALLING

Your dealer can program a group or channel with DTMF signalling. When you receive a call with a code that matches yours, the signalling indicator (:*) will flash and a tone will sound. Squelch opens and you will hear the call.

Squelch will close when you receive a call with a code that matches your signalling reset code.

When making a call on a group or channel programmed with a DTMF signalling code, the signalling indicator will light and the squelch will open.

If your dealer programmed Transpond for DTMF signalling, your transceiver will automatically send an acknowledgment signal to the station that called you with the correct DTMF code.

DBD (DEAD BEAT DISABLE)

Depending on how your dealer programs your transceiver, when you receive a call containing a DBD code, either transmit mode or receive and transmit modes will be disabled. When a DBD code is received, a tone will sound.

DBD is cancelled when you receive a call with a DBD cancel code.

AUDIBLE USER FEEDBACK TONES

The transceiver emits various tones to indicate the transceiver's operating status. Please contact your dealer for further information on these tones.

Note: Only the TK-780 series and TK-880 series transceivers support the tone for Conventional Format.

Tone	Conventional Format	Trunking Format
Alert	Yes	Yes
Busy	Yes	Yes
DBD On	Yes	Yes
DBD Off	Yes	Yes
Delay	No	Yes
Deny	No	Yes
Free System Ring Back Mode/ System Search Mode	No	Yes
Group Call	Yes	Yes
Individual Call	Yes	Yes
Intercept	No	Yes
Key Input Error	Yes	Yes
Key Press [A]	Yes	Yes
Key Press [B]	Yes	Yes
Key Press [C]	Yes	Yes
Password Agreement	Yes	Yes
Power ON	Yes	Yes
Pre Alert	Yes	No
Proceed	No	Yes
PTT Release	Yes	Yes
Queue	No	Yes
Ringling	No	Yes
Roll Over	Yes	Yes
System Search	No	Yes
System Search End	No	Yes
Transpond	Yes	Yes

NOTICES TO THE USER

- ◆ GOVERNMENT LAW PROHIBITS THE OPERATION OF UNLICENSED RADIO TRANSMITTERS WITHIN THE TERRITORIES UNDER GOVERNMENT CONTROL.
- ◆ ILLEGAL OPERATION IS PUNISHABLE BY FINE OR IMPRISONMENT OR BOTH.
- ◆ REFER SERVICE TO QUALIFIED TECHNICIANS ONLY.

SAFETY: It is important that the operator is aware of, and understands, hazards common to the operation of any transceiver.



WARNING

- ◆ **EXPLOSIVE ATMOSPHERES (GASES, DUST, FUMES, etc.)**
Turn OFF your transceiver while taking on fuel or while parked in gasoline service stations. Do not carry spare fuel containers in the trunk of your vehicle if your transceiver is mounted in the trunk area.
- ◆ **INJURY FROM RADIO FREQUENCY TRANSMISSIONS**
Do not operate your transceiver when somebody is either touching the antenna or standing within two to three feet of it, to avoid the possibility of radio frequency burns or related physical injury.
- ◆ **DYNAMITE BLASTING CAPS**
Operating the transceiver within 500 feet of dynamite blasting caps may cause them to explode. Turn OFF your transceiver when in an area where blasting is in progress, or where "TURN OFF TWO-WAY RADIO" signs have been posted. If you are transporting blasting caps in your vehicle, make sure they are carried in a closed metal box with a padded interior. Do not transmit while the caps are being placed into or removed from the container.

One or more of the following statements may be applicable:

FCC WARNING

This equipment generates or uses radio frequency energy. Changes or modifications to this equipment may cause harmful interference unless the modifications are expressly approved in the instruction manual. The user could lose the authority to operate this equipment if an unauthorized change or modification is made.

INFORMATION TO THE DIGITAL DEVICE USER REQUIRED BY THE FCC

This equipment has been tested and found to comply with the limits for a Class B digital device, pursuant to Part 15 of the FCC Rules. These limits are designed to provide reasonable protection against harmful interference in a residential installation.

This equipment generates, uses and can generate radio frequency energy and, if not installed and used in accordance with the instructions, may cause harmful interference to radio communications. However, there is no guarantee that the interference will not occur in a particular installation. If this equipment does cause harmful interference to radio or television reception, which can be determined by turning the equipment off and on, the user is encouraged to try to correct the interference by one or more of the following measures:

- Reorient or relocate the receiving antenna.
- Increase the separation between the equipment and receiver.
- Connect the equipment to an outlet on a circuit different from that to which the receiver is connected.
- Consult the dealer for technical assistance.

Terminal Descriptions

MIC Modular

NO.	Name	Description	Impedance	I/O
1	BLC	MIC back light control output	Low Impedance	O
2	PSB	B(13.6V)	Low Impedance	O
3	E	ground	-	-
4	PTT	PTT signal input. Low : TX.	High Impedance	I
5	ME	Microphone ground	-	-
6	MIC	microphone input	1k ohm	I
7	HOOK	Hook signal input.	High Impedance	I
8	CM	MIC key data output	Low Impedance	O

Antenna Terminal

50 Ω impedance

Power input connector

Red : Battery-line (13.6V)

Black : GND

External speaker jack

Low impedance(Buffer output)

MANDATORY SAFETY INSTRUCTIONS TO INSTALLERS AND USERS

- Use only manufacturer or dealer supplied antenna.
- **Antenna Minimum Safe Distance: 60 cm (2 feet), 50% duty Cycle.**
- Antenna Gain: **0** dBd referenced to a dipole.

The Federal Communications Commission has adopted a safety standard for human exposure to RF (Radio Frequency) energy which is below the OSHA (Occupational Safety and Health Act) limits.

- **Antenna Mounting:** The antenna supplied by the manufacturer or radio dealer must not be mounted at a location such that during radio transmission, any person or persons can come closer than the above indicated minimum safe distance to the antenna, i.e. **60 cm (2 feet) , 50% duty Cycle.**
- To comply with current FCC RF Exposure limits, the antenna must be installed at or exceeding the minimum safe distance shown above, and in accordance with the requirements of the antenna manufacturer or supplier.
- Vehicle installation: The antenna can be mounted at the center of a vehicle metal roof or trunk lid, if the minimum safe distance is observed.
- Base Station Installation: The antenna should be fixed-mounted on an outdoor permanent structure. RF Exposure compliance must be addressed at the time of installation.

Antenna substitution: Do not substitute any antenna for the one supplied or recommended by the manufacturer or radio dealer.

You may be exposing person or persons to excess radio frequency radiation. You may contact your radio dealer or the manufacturer for further instructions.

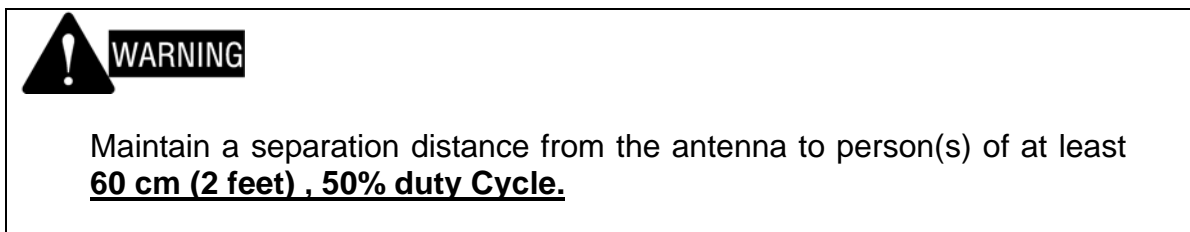

“This transmitter is authorized to operate with a maximum duty factor of 50%, in typical push-to-talk mode, for satisfying FCC RF exposure compliance requirements.”

You, as the qualified end-user of this radio device must control the exposure conditions of bystanders to ensure the minimum separation distance (above) is maintained between the antenna and nearby persons for satisfying RF Exposure compliance. The operation of this transmitter must satisfy the requirements of Occupational/Controlled Exposure Environment, for work-related use, transmit only when person(s) are at least the minimum distance from the properly installed, externally mounted antenna. Transmit only when people outside the vehicle are at least the recommended minimum lateral distance away from the antenna/vehicle